





Catalog Number:	
Project:	
Comments:	
Prepared By:	Date:

### Description

The LC-LG large canopy fixture is available in three outputs and is a direct replacement for 100W-250W HID fixtures one-for-one. With a standard shallow lense this fixture proves to be an ideal stairwell, passageway, and security light.

### Performance Data

Model	Watts	Equiv	Lumens	Efficacy
LC-LG-25 	24W	100W HID	2,819 Lm	115 LPW
LC-LG-40 	41W	175W HID	4,714 Lm	115 LPW
LC-LG-60 	62W	250W HID	6,484 Lm	105 LPW

### Dimensions & Weights

Model	Width	Height	Depth	Weight
LC-LG	12 3/8"	6 1/8"	12 3/8"	14 lbs.

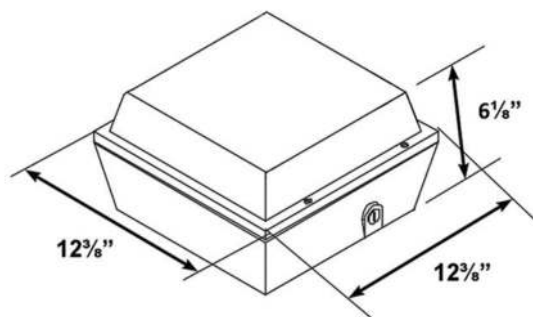

Surface Mount (SFM)

### Technical Specifications

**Input Voltage:** 120-277V or 347-480V

**Housing:** Die cast aluminum housing with textured architectural bronze powder coat finish over a chromate conversion coating. 1/2" coin plugs with O-rings for conduit & photocell installation.

**Lens:** Clear prismatic acrylic lens (low-profile).

**Mounting:** Mount directly over a 4" recessed electrical box or use 1/2" surface conduit.

**Color Temperature:** 2700K WW, 4000K NW (standard), 5000K CW. All LED's are rated for a minimum of 100,000 hours of continuous operation at ambient temperatures from -40°F/-40°C to 95°F/35°C. \*LC-LG-40 and LC-LG-60 ordered in CW are built at 5700K.

**Color Rendering Index (CRI):** Minimum of 70 or higher.

**Dimming:** 0-10V standard dimming capability.

**Surge Protection:** A 20kA surge suppressor is included and complies with IEEE/ANSI C62.41.2 guidelines for "C High." Surge location rated Category C3.

**Lumecon ETD System:** The enhanced thermal dissipation system engines are thermally bonded to provide maximum thermal dissipation to the exterior of the fixture to ensure long life. To protect the light engine panel from moisture and corrosion, the LED light engine panel is uniformly coated with a UV stabilized acrylic polymer resin that meets MIL and ASTM dielectric standards, UL, and IPC standards for flammability, moisture resistance and thermal shock.

**Battery Back-Up (Optional):** When triggered into emergency mode, the BBU operates the LEDs for a code-compliant 90 minutes. When AC power is restored, the driver automatically returns to charging mode. The BBU is a UL recognized component and meets all applicable safety standards.

**Certification Data:** ETL Listed to UL 1598, UL 8750 and CSA 22.2 No. 250 for Wet Locations. \*Full compliance and test documentation is available for TM-21, LM-79, LM-80, ETL Listing to UL1598 and UL 8750, Lighting Facts and DLC. Not all versions of this product may be DLC qualified. For a complete list of Lumecon DLC Qualified Products visit: [www.designlights.org](http://www.designlights.org).

**Manufacturing Origin:** US Manufactured and Assembled.

**Buy American:** Meets Buy American requirements within the ARRA.

**Warranty:** 10 Year L70 performance based warranty. For full warranty terms, please visit our website: [www.lumecon.com](http://www.lumecon.com)



### Ordering Information

LC - LG - Options / Ordering Example: LC-LG-25-DB-SFM-1-NW-X-X-X-OC1-X

WATTAGE	COLOR	MOUNTING	VOLTAGE	COLOR TEMPERATURE	BATTERY BACK-UP
25 - 25 Watts 40 - 40 Watts 60 - 60 Watts	DB - Dark Bronze WH - White C - Custom Color	SFM - Surface Mount	1 - 120v - 277v 2 - 347v - 480v	NW - Neutral CW - Cool* WW - Warm	X - None BB1 - 120v BBU BB2 - 277v BBU BBC1 - 120v BBU Cold Temp Rated* BBC2 - 277v BBU Cold Temp Rated* <i>*Requires external box</i>

SPLIT CIRCUIT	PHOTOCELL	OCCUPANCY SENSOR	INLINE FUSE
X - None SC - Split Circuit	X - None PC1 - 120v PC PC2 - 277v PC PC3 - 347v PC PC4 - 480v PC	X - None OC1 - On/Off OC2 - Dim/High	X - None F - Inline Fuse, 2.5A

If OCC Sensor Option is selected, mounting height specifications need to be clarified:

- Mounting height between 0' - 10'
- Mounting height between 10' - 40'
- Mounting height over 40'+

\*LC-LG-40 and LC-LG-60 ordered in CW are built at 5700K.

### OCC Sensor Patterns

**Coverage Patterns** 0' - 10' Mounting Height

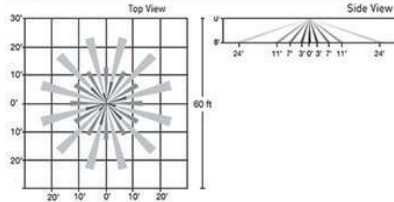

10' - 40' Mounting Height

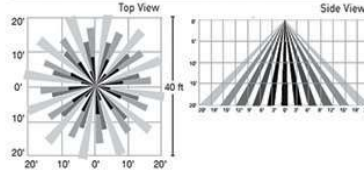

40'+ Mounting Height

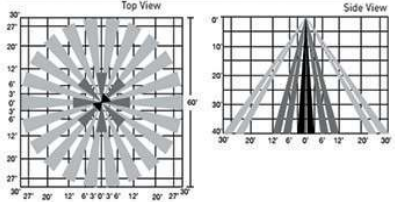

### Options & Accessories



Surface Mount  
Dark Bronze Housing



Surface Mount  
White Housing

### Battery Back-Up

\*An external battery back-up box may be required on certain light fixtures. Please contact Lumecon Sales Agent for clarification.

#### UL Component Recognized / CSA certified

Lumecon's Emergency LED driver has been tested in accordance with the standards set forth in UL 924, "Emergency Lighting and Power Equipment," and with the standards set forth in C22.2 No. 141, "Unit Equipment for Emergency Lighting." Our Emergency LED driver's are UL Component Recognized and CSA Certified for factory installation only. Emergency illumination time exceeds the National Electrical Code (NEC), Life Safety Code (NFPA-LSC), National Building Code of Canada (NBC), National Fire Code of Canada (NFC) and UL 90-minute requirements.



### Photometric Data

\*For .ies files of this product, please visit the downloads tabs on the LC-LG product page: <http://lumecon.com/products/lc-lg-large-stairwell-passageway/>

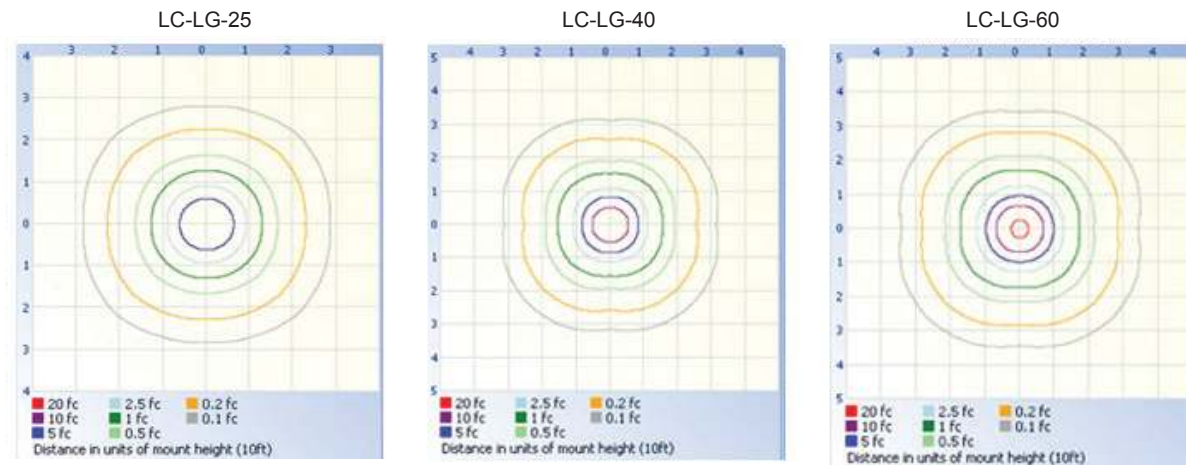

### Photometric Illustration

\*For .ies files of this product, please visit the downloads tabs on the LC-LG product page: <http://lumecon.com/products/lc-lg-large-stairwell-passageway/>

LC-LG-25

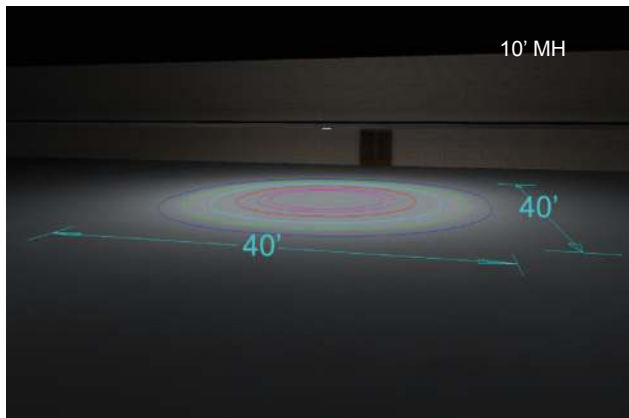

LC-LG-40

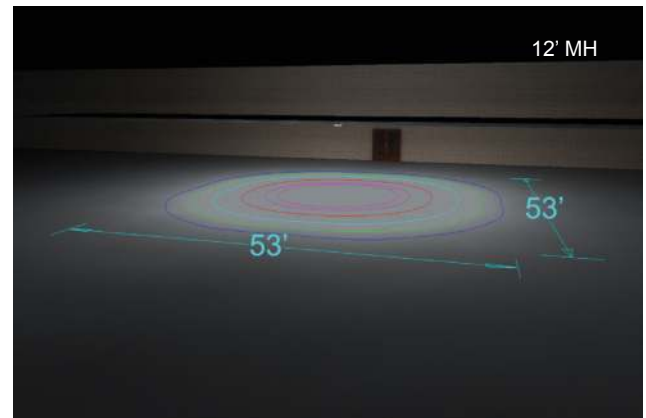

LC-LG-60

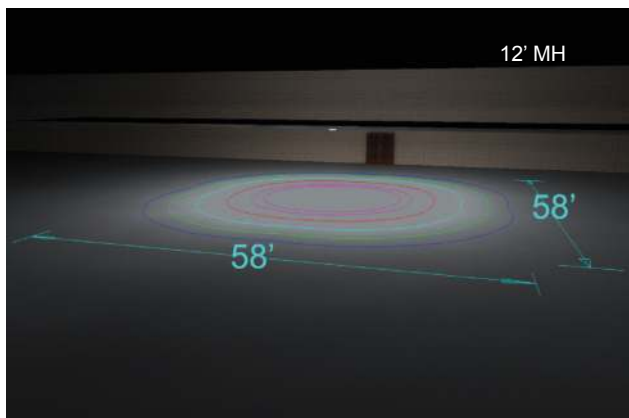

### Performance Data

#### ELECTRICAL LOAD DATA

Fixture Model	Drive Current (mA)	System Watts (W)	AC Current Load (A)			
			120V	208V	240V	277V
LC-LG-25	112	24.5	0.23	0.13	0.11	0.10
LC-LG-40	70	41.1	0.38	0.22	0.19	0.16
LC-LG-60	105	61.9	0.57	0.33	0.29	0.25

#### LUMEN MAINTENANCE

Data in the table below references projected performance in a 25°C ambient and is based on 10,000 hours of LED testing. Performance data has been tested per IESNA LM-80-08 and projected per IESNA TM-21-11.

Use the lumen maintenance factor that corresponds to the desired number of operating hours below to calculate LLF.

#### Lumen Maintenance Factors @ 25°C, by hours:

Fixture Model	0	25,000	50,000	70,000	100,000
LC-LG-25	1.0	0.96	0.93	0.90	0.86
LC-LG-40	1.0	0.95	0.91	0.88	0.84
LC-LG-60	1.0	0.95	0.91	0.88	0.84

### Lighting Facts

